



**SILENT
KNIGHT**

by Honeywell

Model 5104B

Fire Communicator

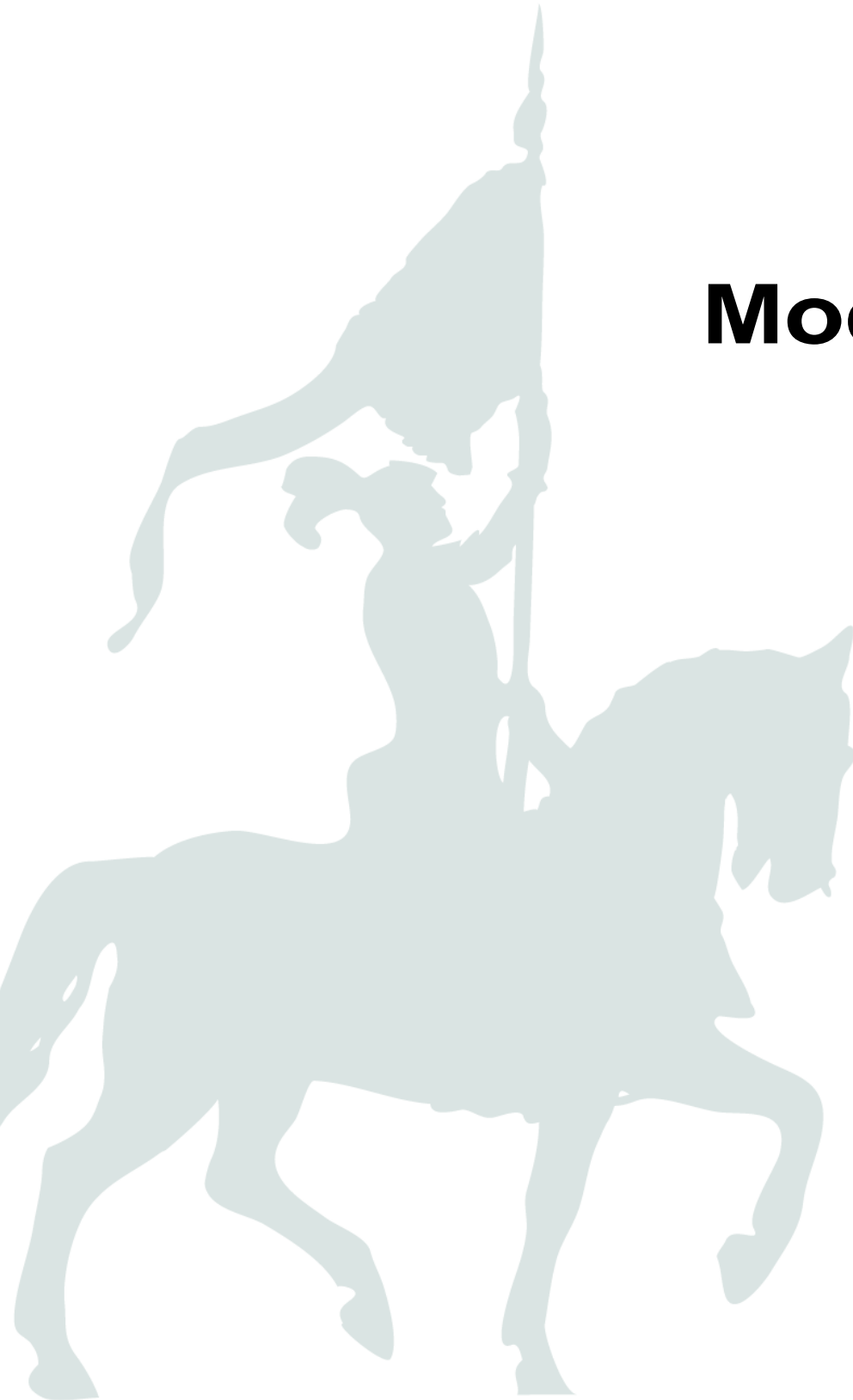

**Installation and
Operations Manual**

Document 151053-L8

Rev: **F4**

P/N 151053-L8-F4 ECN: 16-0259

Installation Procedure

Adherence to the following will aid in problem-free installation with long-term reliability:

Installation Precautions - Adherence to the following will aid in problem-free installation with long-term reliability:

WARNING - Several different sources of power can be connected to the fire alarm control panel. Disconnect all sources of power before servicing. Control unit and associated equipment may be damaged by removing and/or inserting cards, modules, or interconnecting cables while the unit is energized. Do not attempt to install, service, or operate this unit until manuals are read and understood. **CAUTION** - System Re-acceptance Test after Software Changes: To ensure proper system operation, this product must be tested in accordance with NFPA 72 after any programming operation or change in site-specific software. Re-acceptance testing is required after any change, addition or deletion of system components, or after any modification, repair or adjustment to system hardware or wiring. All components, circuits, system operations, or software functions known to be affected by a change must be 100% tested. In addition, to ensure that other operations are not inadvertently affected, at least 10% of initiating devices that are not directly affected by the change, up to a maximum of 50 devices, must also be tested and proper system operation verified. This system meets NFPA requirements for operation within the range of 0°C-49°C (32°F-120°F) or humidity within the range of 10%-93% at 30°C (86°F) non-condensing. However, the useful life of the system's standby batteries and the electronic components may be adversely affected by extreme temperature ranges and humidity. Therefore, it is recommended that this system and its peripherals be installed in an environment with a normal room temperature of 15-27° C/60-80° F. **Verify that wire sizes are adequate** for all initiating and indicating device loops. Most devices cannot tolerate more than a 10% I.R. drop from the specified device voltage. **Like all solid state electronic devices**, this system may operate erratically or can be damaged when subjected to lightning induced transients. Although no system is completely immune from lightning transients and interference, proper grounding will reduce susceptibility. Overhead or outside aerial wiring is not recommended, due to an increased susceptibility to nearby lightning strikes. Consult with the Technical Services Department if any problems are anticipated or encountered. **Disconnect AC power and batteries** prior to removing or inserting circuit boards. Failure to do so can damage circuits. Remove all electronic assemblies prior to any drilling, filing, reaming, or punching of the enclosure. When possible, make all cable entries from the sides or rear. Before making modifications, verify that they will not interfere with battery, transformer, or printed circuit board location. **Do not tighten screw terminals** more than 9 in-lbs. Over-tightening may damage threads, resulting in reduced terminal contact pressure and difficulty with screw terminal removal. Fire alarm control panels contain static-sensitive components. Always ground yourself with a proper wrist strap before handling any circuits so that static charges are removed from the body. Use static suppressive packaging to protect electronic assemblies removed from the unit.

Follow the instructions in the installation, operating, and programming manuals. These instructions must be followed to avoid damage to the control panel and associated equipment. Fire Alarm Control Panel (FACP) operation and reliability depend upon proper installation.

While installing a fire alarm system may make lower insurance rates possible, it is not a substitute for fire insurance! **An automatic fire alarm system** - typically made up of smoke detectors, heat detectors, manual pull stations, audible warning devices, and a fire alarm control with remote notification capability - can provide early warning of a developing fire. Such a system, however, does not assure protection against property damage or loss of life resulting from a fire. **Any fire alarm system** may fail for a variety of reasons: Smoke detectors may not sense fire where smoke cannot reach the detectors such as in chimneys, in walls, or roofs, or on the other side of closed doors. **Smoke detectors** also may not sense a fire on another level or floor of a building. A second floor detector, for example, may not sense a first floor or basement fire. Furthermore, all types of smoke detectors, including ionization and photoelectric types, have sensing limitations. No type of smoke detector can sense every kind of fire caused by carelessness and safety hazards like smoking in bed, violent explosions, escaping gas, improper storage of flammable materials, overloaded electrical circuits, children playing with matches, or arson.

IMPORTANT! Smoke detectors must be installed in the same room as the control panel and in rooms used by the system for the connection of alarm transmission wiring, communications, signaling, and/or power. If detectors are not so located, a developing fire may damage the alarm system, crippling its ability to report a fire. **Audible warning devices** such as bells may not alert people if these devices are located on the other side of closed or partly open doors or are located on another floor of a building. **A fire alarm system** will not operate without any electrical power. If AC power fails, the system will operate from standby batteries only for a specified time. **Rate-of-Rise heat detectors** may be subject to reduced sensitivity over time. For this reason, the rate-of-rise feature of each detector should be tested at least once per year by a qualified fire protection specialist. **Equipment used in the system** may not be technically compatible with the control. It is essential to use only equipment listed for service with your control panel. **Telephone lines** needed to transmit alarm signals from a premise to a central monitoring station may be out of service or temporarily disabled. **The most common cause** of fire alarm malfunctions, however, is inadequate maintenance. All devices and system wiring should be tested and maintained by professional fire alarm installers following written procedures supplied with each device. System inspection and testing should be scheduled monthly or as required by national and/or local fire codes. Adequate written records of all inspections should be kept.

Contents

Section 1

Introduction 1-1

1.1	Feature	1-1
1.2	Accessory Devices	1-1
1.3	About This Manual	1-1
1.3.1	How to Use This Manual	1-2

Section 2

Agency Requirements 2-1

2.1	Telephone Requirements	2-1
2.2	FCC Warning	2-2
2.3	UL Requirements	2-2
2.4	Canadian Department of Communications	2-2

Section 3

Installation 3-1

3.1	Electrical Specifications	3-1
3.2	Environmental Specifications	3-1
3.3	Wiring Specifications	3-2
3.4	Panel Description	3-3
3.4.1	Terminal Description	3-4
3.4.2	LED Descriptions	3-5
3.4.2.1	Externally Visible LEDs (L3, L4, & L5)	3-5
3.4.2.2	Phone Line Fault Indicator LEDs (L6 & L7)	3-5
3.4.2.3	Overcurrent LED Indicators (L1 & L2)	3-6
3.4.3	Reset / Silence Switch	3-6
3.4.4	Cable Connectors (P1, P2, and P3)	3-6
3.4.5	On-board Piezo Sounder	3-6
3.5	Calculating Current Draw and Standby Battery	3-7
3.5.1	Worksheet Requirements	3-7
3.5.1.1	Maximum Battery Standby Load	3-7
3.5.2	Current Draw Worksheet	3-8
3.6	Mounting the 5104 Cabinet	3-9
3.6.1	Preventing Water Damage	3-9
3.7	Mounting the 5104 PC Board	3-9
3.8	AC Connection	3-10
3.8.1	Standard Transformer Connections	3-10
3.9	Battery Connection	3-10
3.10	Detector Installation	3-11
3.10.1	Class A (Style D) Zones	3-11
3.10.2	Class B (Style B) Zones	3-12
3.10.3	Four-Wire Smoke Detector Connection	3-13
3.11	Supplemental Notification Appliance Installation	3-14
3.11.1	Non-Supervised Notification Appliance Wiring	3-14

3.11.2 Supervised Notification Appliance Wiring	3-15
3.12 Telephone Line Connections	3-16
3.13 Model 5230 Installation	3-17
3.13.1 Mounting the 5230	3-17

Section 4
Add-on Fire Communicator Application 4-1

Section 5
5230 Operation 5-1

5.1 5230 Display Messages	5-1
5.2 5230 Touchpad Functions	5-2

Section 6
Programming 6-1

6.1 UL 864 Programming Requirements	6-1
6.2 5230 Programming	6-1
6.2.1 Default User Codes	6-1
6.2.2 How to Enter and Exit Program Mode	6-1
6.2.3 How to Enter Program Mode	6-1
6.2.4 How to Exit Program Mode	6-2
6.2.5 Step Programming	6-2
6.2.6 Maneuvering in Program Mode	6-2
6.2.6.1 Entering Selected Values	6-2
6.2.6.2 Bypass a Step	6-3
6.2.6.3 Go to a Step	6-3
6.2.7 Programming Steps	6-3

Section 7
Reporting 7-1

7.1 Reporting Formats	7-1
7.2 Reporting Codes	7-2

Section 8
Troubleshooting 8-1

Silent Knight Fire Product Warranty and Return Policy
Manufacturer Warranties and Limitation of Liability

Section 1

Introduction

The Model 5104 is a low-cost fire communicator that meets the requirements for NFPA 72, UL 864, MEA, CSFM, and FM.

1.1 Feature

- Six supervised fire zones, consisting of one Class A (Style D) and five Class B (Style B) zones.
- Current limited loop power output for the Class B zone inputs.
- Ground fault detection.
- Built-in piezo sounder for trouble and supervisory conditions.
- Reset/Silence switch that performs the following:
 - 1 Silences troubles and alarms.
 - 2 Resets smoke detector power.
 - 3 Resets accessory power.
- Supervision of Reset/Silence switch. If the switch is depressed for 15 seconds or longer, an audible trouble signal will occur. See section 3.4.3
- 24 hour battery backup from a 12 VDC, 7 Ah rechargeable battery.
- Separate battery charging circuit that maximizes battery life.
- Multiple reporting formats (SIA, SK 3/1, SESCOA 3/1, Contact ID, SK 4/2, Radionics BFSK).
- Programmable relay output provides additional annunciation for either alarm or dialer-failed condition.
- Three LEDs indicating AC power (green) status, Trouble Silenced (yellow), and Dialer Failed (yellow).
- Four LEDs inside cabinet indicate short circuits and trouble conditions.
- Easy, English-language programming using the 5230 Remote Annunciator.
- Versatile two-number dialing feature for reporting to two different numbers.
- Programmable dialing format (rotary or Touch Tone).
- Two phone line monitoring and seizure circuits.
- Transient Voltage protection on all inputs (AC, phone lines, accessory zones).
- Automatic daily test.
- EEPROM memory storage of all programmed information.

1.2 Accessory Devices

- Model 5230 Remote Annunciator (optional). Used for system control, programming and troubleshooting.
- Model 7860 modular cable with spade lugs for connection to Telco RJ31X plug (optional).

1.3 About This Manual

This manual is intended for those persons involved with the installation and maintenance of the 5104 Fire Communicator. It is a comprehensive guide providing detailed instructions, and should be kept for reference. As

much as possible, we have tried to organize the manual chronologically by the tasks that need to be performed. Please let us know if the manual does not meet your needs in any way.

1.3.1 How to Use This Manual

In this manual, the following conventions are used:

- Pages of the manual are numbered by section. For example, a page numbered as 5-1 is page 1 of Section 5.
- Text in this type face indicates a 5230 display message: System Normal.

Note: All references to 5104 throughout this manual are applicable to 5104B.

Section 2

Agency Requirements

This section list all the requirements for the 5104 by agency.

Install and maintain in accordance with NFPA 72. Detector spacing shall be in accordance to NFPA 72. End-of-line relays and resistors shall be placed within the electrical box located and the end of the initiating circuit. Testing and maintenance should be performed according to NFPA 72.

2.1 Telephone Requirements

If requested by telephone company the following information must be provided before connecting this device to the phone lines:

- | | | |
|----|----------------------------------------------------------|-------------------|
| A. | Manufacturer: | Silent Knight |
| B. | Model Number: | 5104B |
| C. | FCC Registration Number: | AC698R-17462-AL-E |
| D. | Type of jack (to be installed by the telephone company): | RJ31X |
| | Ringer equivalence: | 0.1B |

This device may not be directly connected to coin operated telephones or party line services.

This device cannot be adjusted or repaired in the field. In case of trouble with device, notify the installing company or Silent Knight for an RA number and then return it to:

Silent Knight
12 Clintonville Road
Northford, CT 06472-1610
800-328-0103 or 203-484-7161

If the Model 5104 causes harm to the telephone network, the telephone company will notify the user in advance that temporary discontinuance of service may be required. If advanced notice is not practical the telephone company will notify the customer as soon as possible. You as the user have the right to file a complaint with the Federal Communications Commission if you believe it is necessary.

The telephone company may make changes in its facilities, equipment, operations, or procedures that could affect the operation of the equipment. If this happens, the telephone company will provide advance notice to allow you to make the necessary modifications to maintain uninterrupted service.

2.2 FCC Warning

Warning

This device has been verified to comply with FCC Rules Part 15. Operation is subject to the following conditions: (1) This device may not cause radio interference, and (2) This device must accept any interference received, including interference that may cause undesired operation.

2.3 UL Requirements

The 5104 is UL listed as a Control Unit for use in Central Station Fire-Protective Signaling Systems (UL864, NFPA 72). All UL installations must comply with the following requirements:

1. The 120 VAC wiring to the 5104 cabinet must be enclosed in conduit.
2. Total standby current must not exceed 275 mA for central station use or 105 mA for remote station use.
3. All electrical connections must comply with ratings shown in Section 3.

Restricted Options:

- The loss of AC signal is defaulted to 3 hours however the system allows settings from 0 - 30 hours. For UL certified installations this number must be set from 1 to 3 hours.
- Call forwarding shall not be used.

2.4 Canadian Department of Communications

The Canadian Department of Communications label identifies certified equipment. This certification means that the equipment meets certain telecommunications network protective, operational and safety requirements. The Department does not guarantee the equipment will operate to the user's satisfaction.

Before installing this equipment, users should ensure that it is permissible for the equipment to be connected to the facilities of the local telecommunications company. In some cases, the company's inside wiring associated with a single line individual service may be extended by means of a certified connector assembly (telephone extension cord). The customer should be aware that compliance with the above conditions may not prevent degradation of service in some situations.

Repairs to certified equipment should be made by an authorized Canadian maintenance facility designated by the supplier. Any repairs or alterations made by the user to this equipment; or equipment malfunctions, may give the telecommunication company cause to request the user to disconnect the equipment.

Users should ensure for their own protection that the electrical ground-connections of the power utility, telephone lines and internal metallic water pipe system, if present, are connected together. This precaution may be particularly important in rural areas.

CAUTION: Users should not attempt to make such connections themselves, but should contact the appropriate electric inspection authority, or electrician, as appropriate.

Section 3

Installation

This section contains information necessary to install the 5104 Fire Communicator and accessories.

3.1 Electrical Specifications

Primary AC	120 Vrms @ 60Hz, 374 ma
Total DC load	1.3 Amp
Accessory Power	12 VDC @ 750 mA
Phone Line Voltage	2.75 VDC min.
Smoke Power	12 VDC @ 750 mA
Battery Charging Voltage	13.8 VDC
Minimum Low Battery Detection	10.2 VDC
Minimum Low AC Detection	102 Vrms @ 60 Hz, full load
Auxiliary Notification Appliance Circuit	12 VDC @ 500 mA

3.2 Environmental Specifications

It is important to protect the 5104 panel from water. To prevent water damage, the following precautions should be FOLLOWED when mounting the unit:

- Mount indoors in dry locations only
- Do not mount directly on exterior walls, especially masonry walls (condensation).
- Do not mount directly on exterior walls below grade (condensation).
- Protect from plumbing leaks.
- Protect from splash caused by sprinkler system inspection ports.
- Do not mount in areas with humidity-generating equipment (such as dryers, production machinery, etc.).
- Operating temperature range is 32° to 120° F (0° to 49° C).
- Indoor use only.
- 10% to 93% non-condensing humidity at 30°C (86°F).
- Non-corrosive environment.

3.3 Wiring Specifications

Induced noise (transfer of electrical energy from one wire to another) can interfere with telephone communication or even cause false alarms. To avoid induced noise, follow these guidelines:

- Isolate input wiring from high current output and power wiring. Do not pull one multi-conductor cable for the entire panel. Instead, separate the wiring as follows:

High Voltage	AC Power
Audio input/output	Phone Line Circuits, Terminals 13-20
Notification Circuits	Terminals 21-22
Data Communication Circuits	Terminals 25-26

- Do Not pull wires from different groups through the same conduit. If you must run them together, do so for as short a distance as possible or use shielded cable. Connect the shield to earth ground at the panel only.
- High frequency noise, such as that produced by the inductive reactance of a speaker or bell, can also be reduced by running the wire through ferrite shield beads or by wrapping it around a ferrite toroid.
- Route the wiring around the inside perimeter of the cabinet. It should not cross the circuit board where it could induce noise into the sensitive microelectronics or pick up unwanted RF noise from the high speed circuits. See Figure 3-1 for an example.

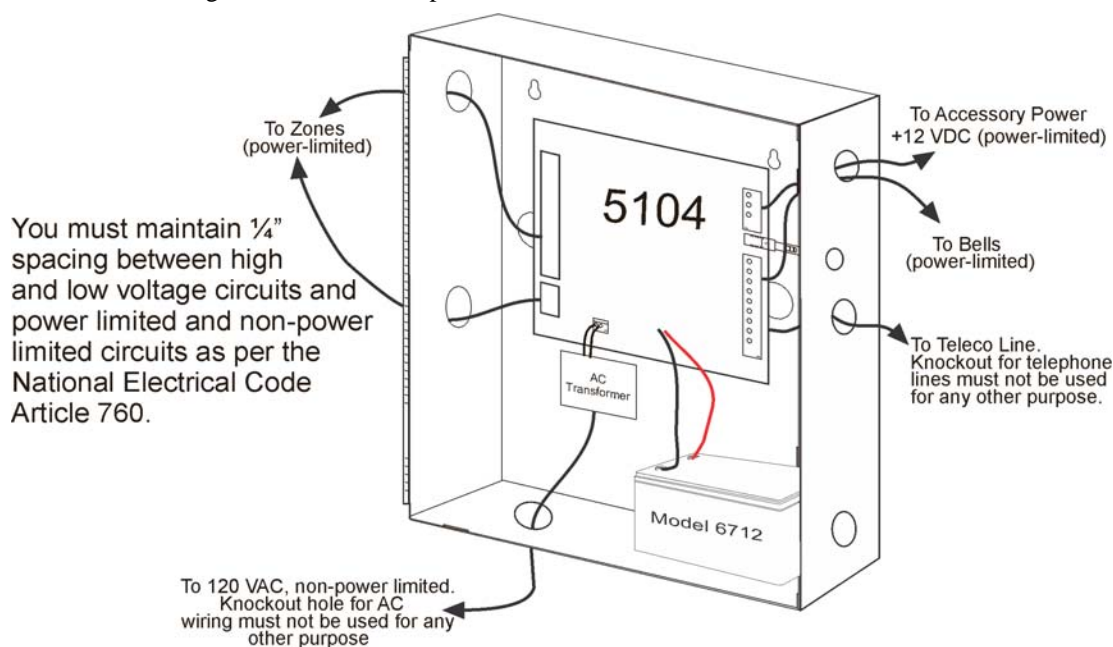

Figure 3-1 Wire Routing Example

3.4 Panel Description

This section describes the 5104 board components, including terminal strips, LEDs, Switches and cable connectors. See Figure 3-2.

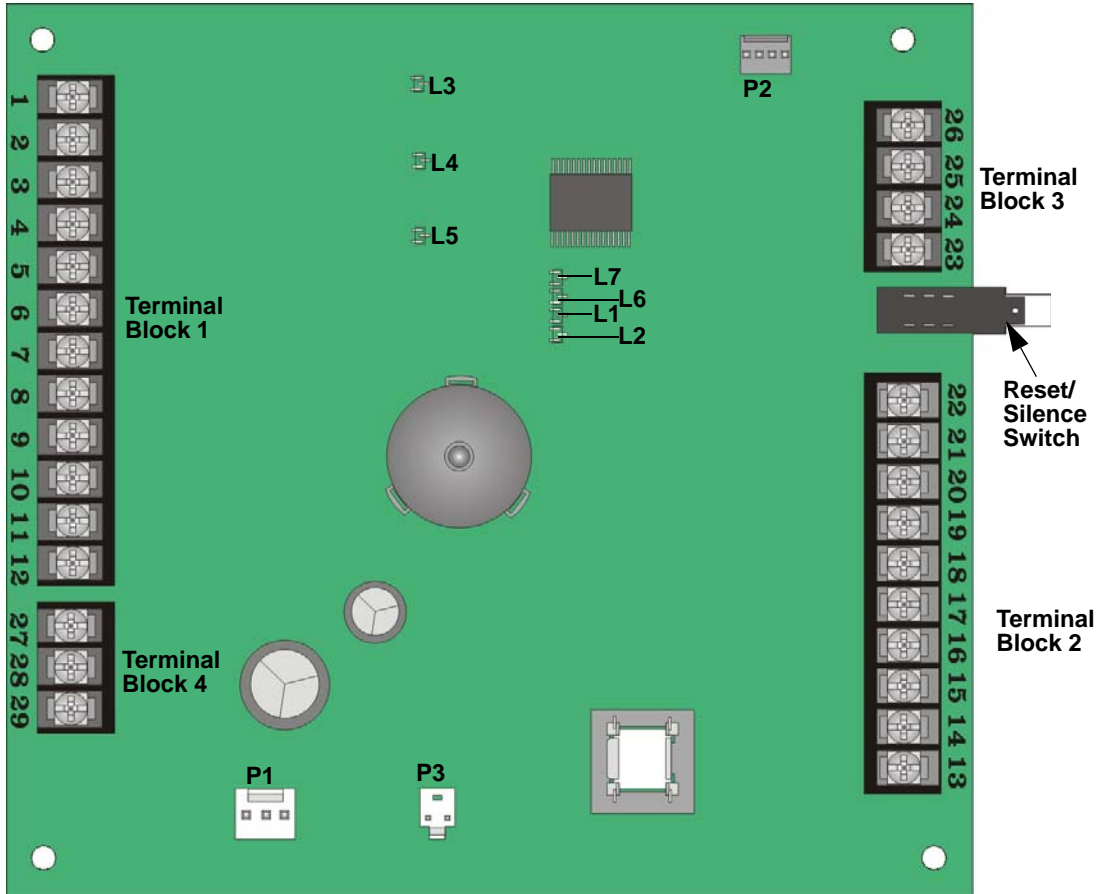

Figure 3-2 5104 Circuit Board

3.4.1 Terminal Description

Table 3-1 lists the terminals by number and describes the terminals use.

Table 3-1: Terminal Description by Terminal Block

Terminal Block #	Terminal #	Description	Electrical Specification	Earth Ground Impedance (in Ohms)	
1	1	Loop A output (Class A Style D)	(Power Limited)	0	
	2	Loop B output		0	
	3	Loop B input		0	
	4	Loop A input		0	
	5	Input (Class B Style A)	(Power Limited)	0	
	6	Power		0	
	7	Circuit Ground		0	
	8	Input (Class B Style A)	(Power Limited)	0	
	9	Power		0	
	10	Input (Class B Style A)	(Power Limited)	0	
	11	Power		0	
	12	Circuit Ground		0	
2	13	Telco Ring	Phone Line 1	N/A	
	14	Telco Tip		N/A	
	15	House Ring		N/A	
	16	House Tip		N/A	
	17	Telco Ring	Phone Line 2	N/A	
	18	Telco Tip		N/A	
	19	House Ring		N/A	
	20	House Tip		N/A	
	21	Bell (+) positive	Notification Circuit	(Power Limited)	0
	22	Bell (-) negative		0	
3	23	Ground	5230 Annunciator (Optional)	0	
	24	Accessory Power		(Power Limited)	0
	25	Serial Data Out		(Power Limited)	0
	26	Serial Data In		0	
4	27	Input (Class B Style A)	(Power Limited)	0	
	28	Power		0	
	29	Input (Class B Style A)		0	

3.4.2 LED Descriptions

This section describes what each LED indicates. The 5104 has a total of seven LEDs, three are visible externally and four are visible only if the cabinet door is open. See Section 8 for additional information on LED operation.

3.4.2.1 Externally Visible LEDs (L3, L4, & L5)

This section describes the three LEDs (one green and two yellow) that are visible externally through the window on the 5104 cabinet door. Refer to Table 3-2 and Figure 3-2.

Table 3-2: Externally Visible LEDs

LED #	Name	Color	Description
L3	Power	Green	Normally ON unless the panel loses AC power or the panel is being reset.
L4	Silenced	Yellow	Normally OFF unless a trouble or supervisory condition has been silenced.
L5	Dialer	Yellow	Normally OFF unless there is a phone line or communication problem. See Section 3.4.2.2 for additional information.

3.4.2.2 Phone Line Fault Indicator LEDs (L6 & L7)

The 5104 has a built-in dual-phone line monitoring circuit. This circuit detects any fault in the phone line by monitoring the loop current and DC voltage. If the phone line drops to 1.8 VDC @ 5 mA or below for 40 to 90 seconds the on-board piezo and the corresponding LED will turn ON. The control panel will then report the fault condition to the central station on the other phone line. For example, if phone line one loses phone line voltage, the on-board piezo and the L6 will turn on, then the control panel will report the faulted line on phone line two. See Figure 3-2 for LED Locations

Note: To comply with NFPA 72 the model 5104 is equipped with phone line seizure. This means that any time the control panel dialer needs to communicate with the central station, it will not be possible to use the telephones that are on the same line as the fire system. During communication to the central station the phone lines will be seized for approximately one minute. However, under adverse telephone circuit conditions phone line seizure could last as long as 15 minutes.

Table 3-3: Phone Line Fault Indicator LEDs

LED #	Name	Color	Description
L6	Phone Line 1 Fault	Red	Visible only when the 5104 cabinet is open. If ON indicates that phone line 1 is faulted. A faulted condition is indicated if the phone line voltage drops below 1.8 VDC and the loop current is less than 5 mA. Flashing indicates a communication error has occurred.
L7	Phone Line 2 Fault	Red	Visible only when the 5104 cabinet is open. If ON indicates that phone line 2 is faulted. A faulted condition is indicated if the phone line voltage drops below 1.8 VDC and the loop current is less than 5 mA. Flashing indicates a communication error has occurred.

3.4.2.3 Overcurrent LED Indicators (L1 & L2)

The 5104 has two red LEDs which indicate if excessive current is being drawn by a device connected to either the Accessory Power or Smoke Power circuits. Table 3-4 lists the two overcurrent LEDs and gives a description of them. See Figure 3-2 for LED locations.

Table 3-4: Overcurrent LED Description

LED #	Name	Color	Description
L1	Accessory Power Fault	Red	If a device connected to the accessory power circuit draws more than 750 mA the overcurrent poly fuse will open and L1 will turn on.
L2	Smoke Power Fault	Red	If a device connected to the smoke power circuit draws more than 750 mA the overcurrent poly fuse will open and L2 will turn on.

If either L1 or L2 turn on disconnect power immediately. Refer to Section 8 for troubleshooting information.

3.4.3 Reset / Silence Switch

The Reset/Silence switch has three functions:

- Silences audible trouble, or supervisory signals. A trouble or supervisory piezo annunciation will be silenced immediately when you press the switch.

Note: If the switch is depressed for 15 seconds or longer an audible trouble signal will occur

- Resets smoke detector power. This function removes power from terminals 6, 9 and 11.

Note: To reset smoke detector power, depress the reset/trouble switch for a minimum of 1 second.

- Reset accessory powered devices. This function removes power from terminal 24.

Note: To reset accessory powered devices depress the reset/silence switch for a minimum of 1 second

The Reset/Silence switch is accessible inside the panel (DO NOT install the switch extender provided with the system) for UL certified installations.

3.4.4 Cable Connectors (P1, P2, and P3)

There are two connectors on the 5104 (see Figure 3-2 for P1 and P2 locations). The function of these connectors is as follows:

Connector	Function
P1	Connects the wires from the secondary winding of the AC transformer to the control panel. (See Section 8 <i>Troubleshooting</i> for additional information.
P2	Used as a quick-connect for the 5230 Remote Annunciator to do programming or troubleshooting.
P3	Standby battery connector.

3.4.5 On-board Piezo Sounder

The on-board piezo sounder gives an audible output for trouble, and supervisory conditions. Troubles and supervisorys can be silenced with the Reset/Silence switch immediately.

3.5 Calculating Current Draw and Standby Battery

This section should be used to help you determine the current draw and standby battery needs for your installation.

3.5.1 Worksheet Requirements

The following steps must be taken when determining the 5104 current draw and standby battery requirements.

Fill in the Current Draw Worksheet (Table 3-6) in section 3.5.2.

For the 5104, the worst case current draw is listed in Table 3-6 for the panel and accessory devices.

Follow these steps to properly fill in the Current Draw Worksheet.

1. Fill in the number of devices used.
2. Compute the current draw requirements for alarm and standby and record this data into line A.
3. Add up the current draw for all the smoke detectors and record the totals in line B.
4. Total all the notification appliance device loads and enter that number into line C.
5. Make sure that the alarm current you calculated, including current for the panel itself, does not exceed 750 mA. This is the maximum current allowable.
6. Complete the remaining instructions in Table 3-6 to determine battery size requirements.

3.5.1.1 Maximum Battery Standby Load

Table 3-5 shows the maximum battery standby load for the 5104 based on 24 and 60 hours of standby. the standby load calculations of line D in Table 3-6 must be less than the number shown in Table 3-5 for the battery size used and standby hours required.

Table 3-5: maximum Battery Standby Load

Rechargeable Battery Size	Maximum Load for 24 hrs. Standby, 5 min. Alarm	Maximum Load for 60 hrs. Standby, 5 min. Alarm
7 AH	275 mA	105 mA

3.5.2 Current Draw Worksheet

Use this worksheet to determine current requirements during alarm/battery standby operation.

Table 3-6: Current Draw Calculations

Device	Number of Devices	Current per Device	Standby Current	Alarm Current
<i>For each device use this formula:</i>				
	<i>This Column</i>	<i>x This Column</i>	<i>= Current per number of devices</i>	
5104	1	Standby: 75 mA	75 mA	
		Alarm: 135 mA		135 mA
5230	3 max	Standby: 60 mA	mA	
		Alarm: 120 mA		mA
A	Current Subtotals:		mA	mA
Smoke Detectors				
		Standby: mA	mA	
		Alarm: mA		mA
		Standby: mA	mA	
		Alarm: mA		mA
		Standby: mA	mA	
		Alarm: mA		mA
		Standby: mA	mA	
		Alarm: mA		mA
B	Current Subtotals:		mA	mA
Notification Appliances				
				mA
				mA
				mA
				mA
C	Current Subtotals:			mA
D	Total current rating of all devices in system (add totals of A-C) x .001:		A	A
E	Number of standby hours. (24 or 60 for NFPA 72, chapter 1, 1-5.2.5):		H	
F	Multiply lines D (standby current) and E. Total standby AH		AH	
G	Alarm sounding period in hours. (For example, 5 minutes = .0833 hours)			H
H	Multiply lines D (alarm Current) and G totals Total alarm AH			AH
I	Add lines F and H. AH = Ampere Hours Total AH required		AH	

3.6 Mounting the 5104 Cabinet

Read the environmental specifications in Section 3.2 before mounting the 5104 cabinet. This will ensure that you select a suitable location.

The panel should be accessible to main drop wiring runs. It should be mounted as close to the center of the building as possible and located within a secured area, but should be accessible for testing and service.

When mounting on interior walls, use appropriate screw anchors in plaster. When mounting on concrete, especially when moisture can accumulate, the enclosure shall be placed or equipped so as to prevent moisture or water from entering and accumulating within the cabinet, and shall be mounted so there is a least 1/4" space between the enclosure and the concrete wall surface. A piece of plywood, standoffs, or other equivalent material can be used to space the cabinet from the concrete surface and then attach the 5104B to that spacing surface. Also mount any other desired components to the 1/4" spacing surface.

DO NOT flush-mount the 5104B cabinet in a wall designated as a fire break.

3.6.1 Preventing Water Damage

Water damage to the fire system can be caused by moisture entering the cabinet through the conduits. Conduits that are installed to enter the top of the cabinet are most likely to cause water problems. Installers should take reasonable precautions to prevent water from entering the cabinet. Water damage is not covered under warranty.

3.7 Mounting the 5104 PC Board

Since the 5104 panel ships with the PC board installed, this section is intended only for installations in which the 5104 PC board is being replaced. Line up the four PC board mounting holes with the four standoffs in the cabinet as shown in Figure 3-3, and use four mounting screws to secure the board to the cabinet.

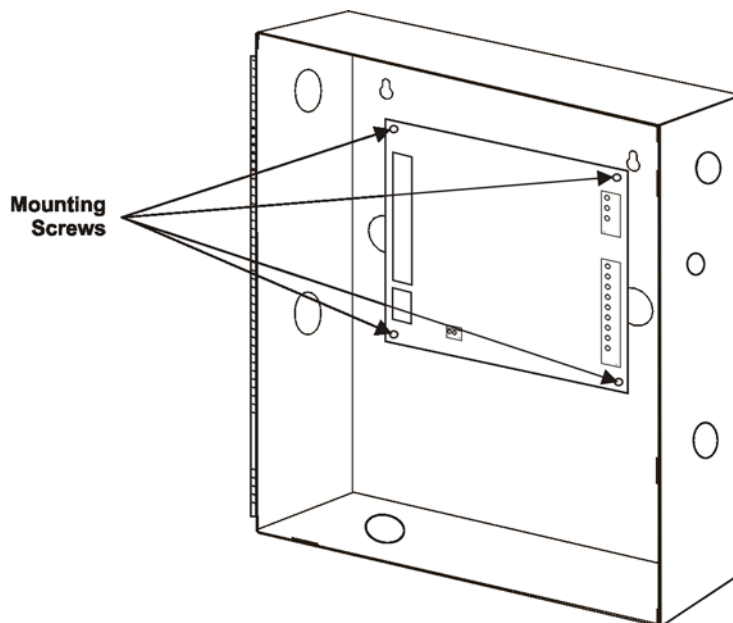

Figure 3-3 Mounting the 5104 PC Board

3.8 AC Connection

3.8.1 Standard Transformer Connections

The AC transformer is factory mounted into the control panel and is plugged onto the control panel as shown in Figure 3-4. The ground and the primary side of the transformer should be wired as shown in Figure 3-4 by a certified electrician.

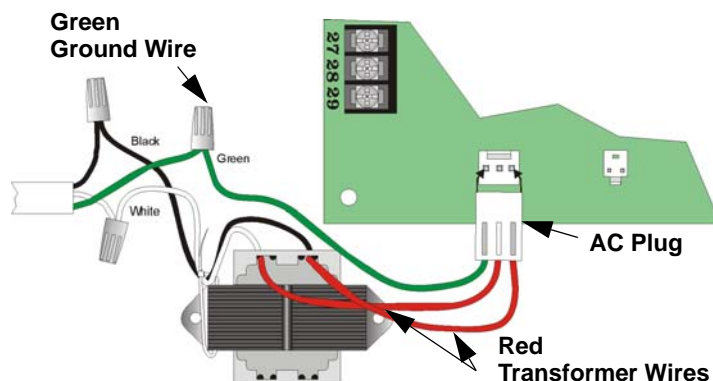

Figure 3-4 AC Transformer Connections

3.9 Battery Connection

The battery provides backup power to the system during AC power loss. Connect the 12 VDC battery (SK Model 6712) as shown in Figure 3-5.

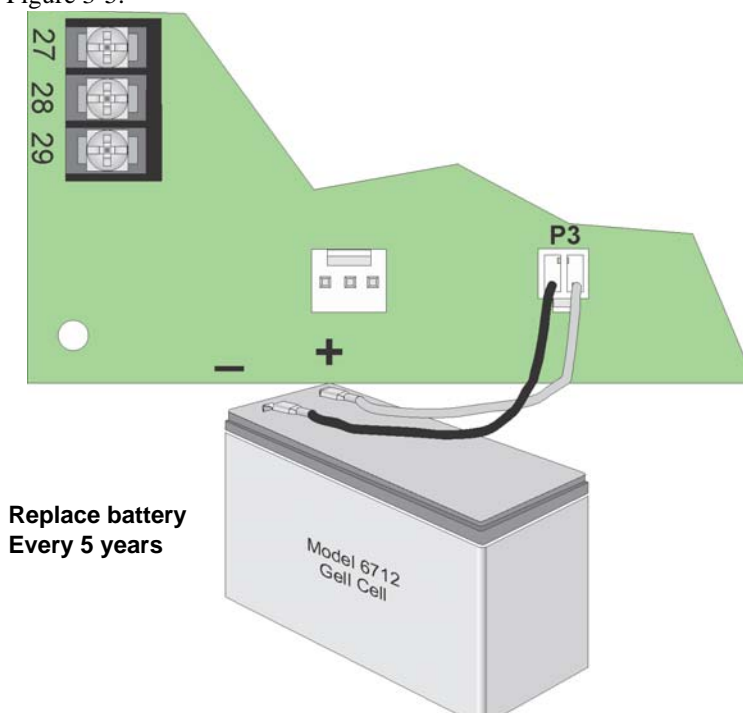

Figure 3-5 Backup Battery Connections

Note: Observe proper polarity when connecting the 12 VDC battery to 5104. If polarity is reversed, a resettable overcurrent protection device on the 5104 will automatically open removing power from the panel.

3.10 Detector Installation

3.10.1 Class A (Style D) Zones

Zones 1 is for a class A (style D) zone. It is intended for use with non-powered devices such as waterflow switches. Do NOT use smoke or duct detectors on Class A zones.

Each class A zone is a four-wire circuit that allows an alarm to be detected even after a single open or ground fault occurs. When a single open or ground fault occurs, the audible trouble signal will sound and the 5104 will report the trouble to the central station.

Figure 3-6 shows how to wire a class A (style D) loop. No end-of-line (EOL) resistor is needed for this zone. This zone must be wired using normally open contacts.

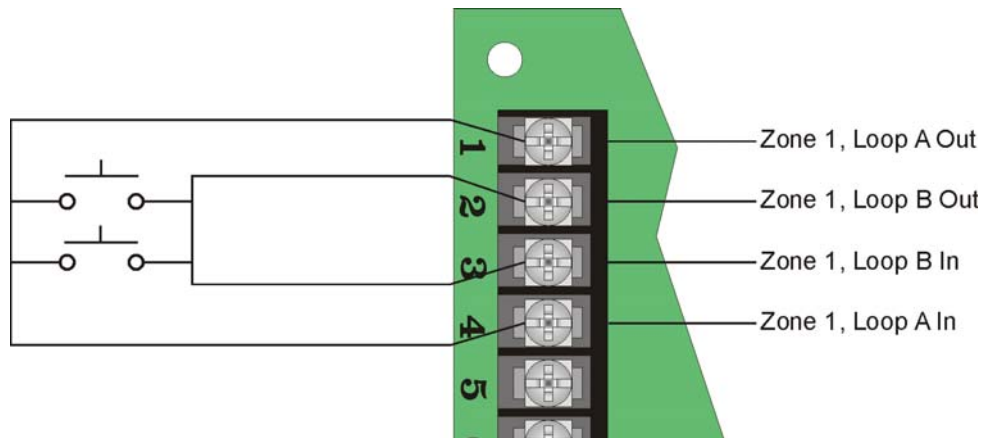

**Figure 3-6 Class A (style D) Supervised Fire Loop
(Normally Open Sensors Only)**

Note: Class A wiring is to be used for dry contacts only and does not support 2-wire detectors.

3.10.2 Class B (Style B) Zones

Zones 2 through 6 are class B (style B) fire zones. Each class B zone consists of a two-wire circuit that will detect the occurrence of an open in the loop, but may not be able to detect an alarm after such an occurrence. The detection of an open will cause the audible trouble signal to sound and the 5104 will report the trouble to the central station.

Figure 3-7 shows how to wire a class B (style B) loop. One side of each class B loop connects to a zone input terminal and the other side of each loop connects to loop power. For each loop, use a 4.7K-ohm EOL resistor wired in parallel with the normally open contact farthest from the panel.

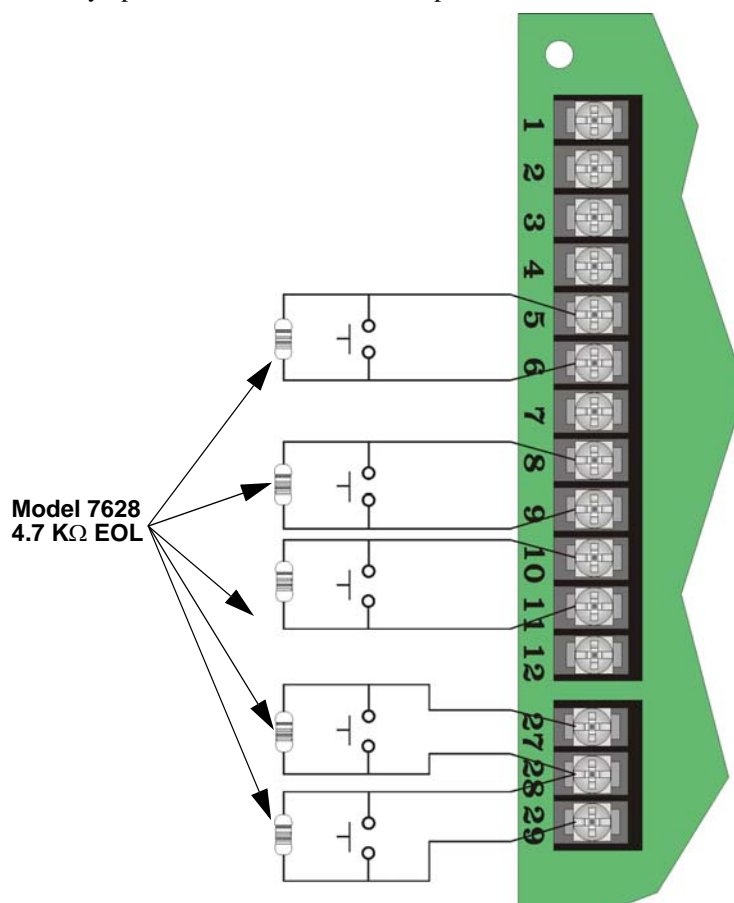

Figure 3-7 Model 5104B Class B (Style B) Loops

Note: Does not support 2-wire detectors.

Maximum Loop Resistance - 50 ohms

Maximum Total alarm current for all class B (Style B) zones - 750 mA

Maximum Standby Current per Zone:

Output (loop power)	750 mA
Input	0.5 mA

Note: UL requires all wiring to be at least 18 gauge.

3.10.3 Four-Wire Smoke Detector Connection

4-wire smoke detectors must use a power supervision module. Connect four-wire smoke detectors as shown in Figure 3-8.

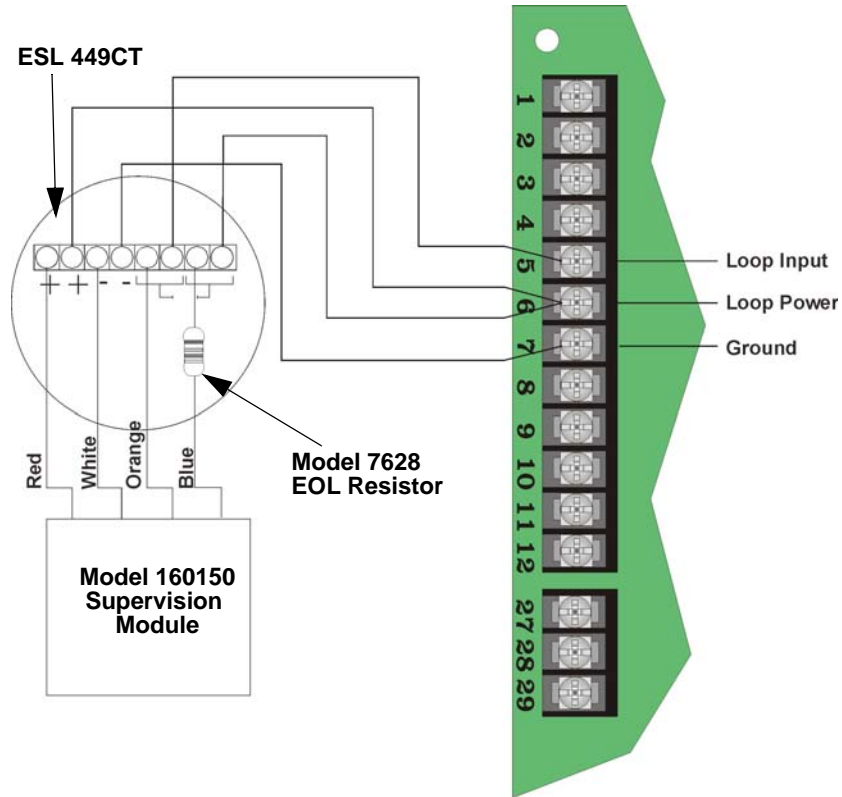

Figure 3-8 4-wire Smoke Detector Connections

3.11 Supplemental Notification Appliance Installation

The Supplemental notification circuit supplies a DC output that can be used to power a DC audible device during an alarm condition. Pressing the reset / silence switch will silence the output. Refer to section 6.2.7, Step 14, to program the notification circuit's supervision properties.

3.11.1 Non-Supervised Notification Appliance Wiring

Figure 3-9 illustrates how to wire a non-supervised notification device to the control panel.

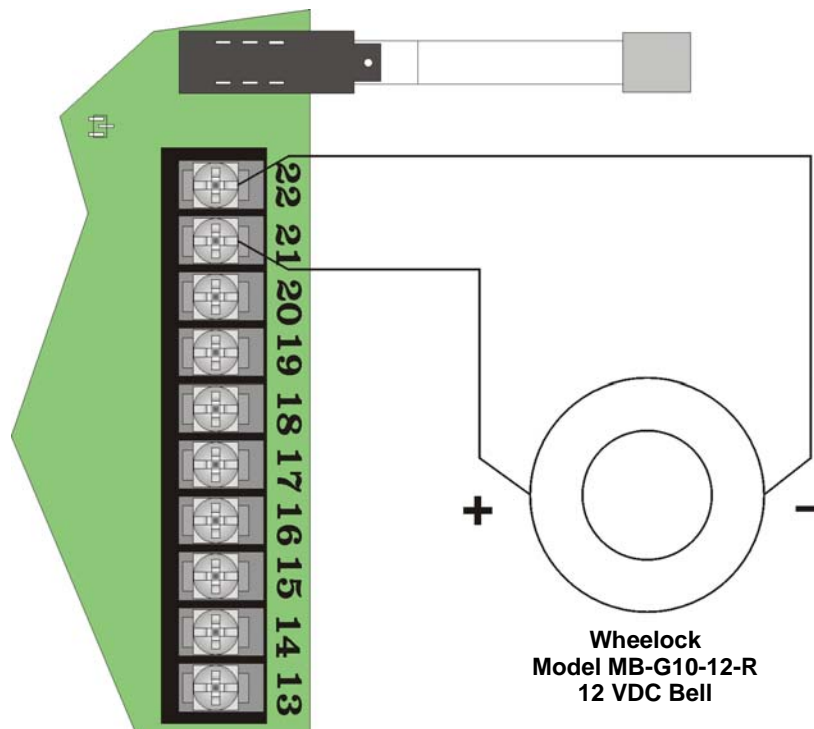

Figure 3-9 Non-Supervised Alarm Bell Wiring

Note: Polarities shown in Figure 3-9 illustrate the polarity in an alarm condition. Under normal conditions the polarity of terminals 21 and 22 are reversed.

Note: Per NFPA 72 Requirements the means of silencing a Supervisory Signal or Alarm must be located within a locked cabinet. To comply, DO NOT install the reset/silence switch extruder or remove the switch knock-out.

3.11.2 Supervised Notification Appliance Wiring

When using a supervised notification device any open or shorted wiring condition will be reported as a trouble. Figure 3-10 illustrates how to wire a supervised notification device to the control panel. Refer to Section 6.2.7 Step 14 to program the notification circuit's supervision properties.

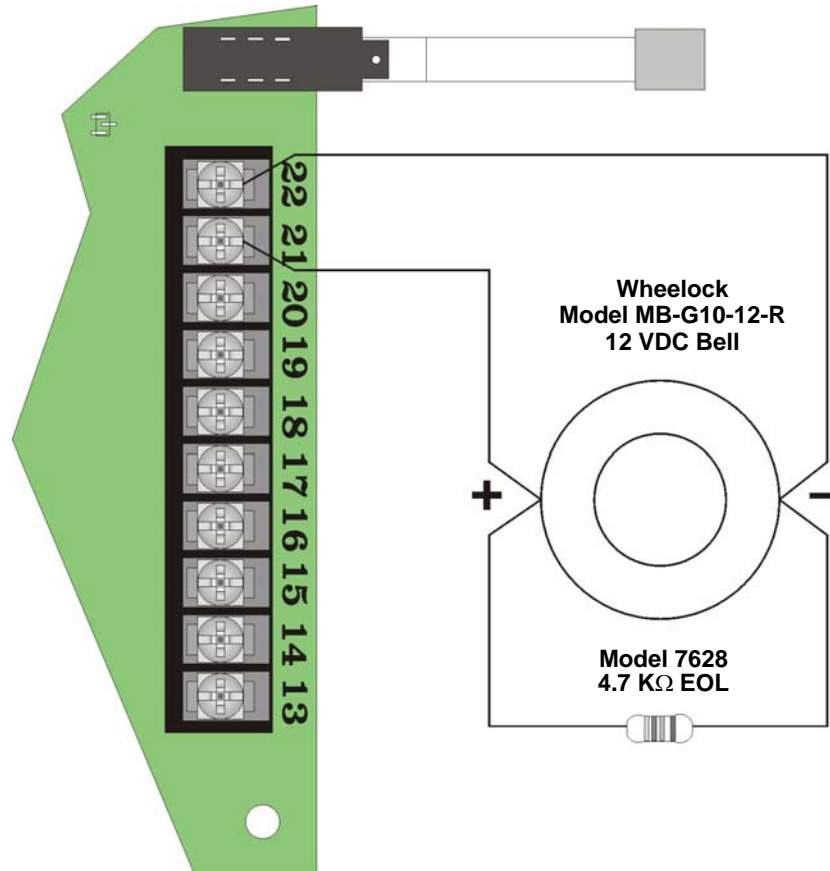

Figure 3-10 Supervised Alarm Bell Wiring

Note: Polarities shown in Figure 3-10 illustrate the polarity in an alarm condition. Under normal conditions the polarity of terminals 21 and 22 are reversed.

3.12 Telephone Line Connections

The 5104 control panel connects to the phone lines with a 7860 cable, which plugs into an RJ31X phone jack. The telephone company will install an RJ31X phone jack if you request them. Both telephone lines must be installed to comply with NFPA 72. Wire the phone lines as shown in Figure 3-11.

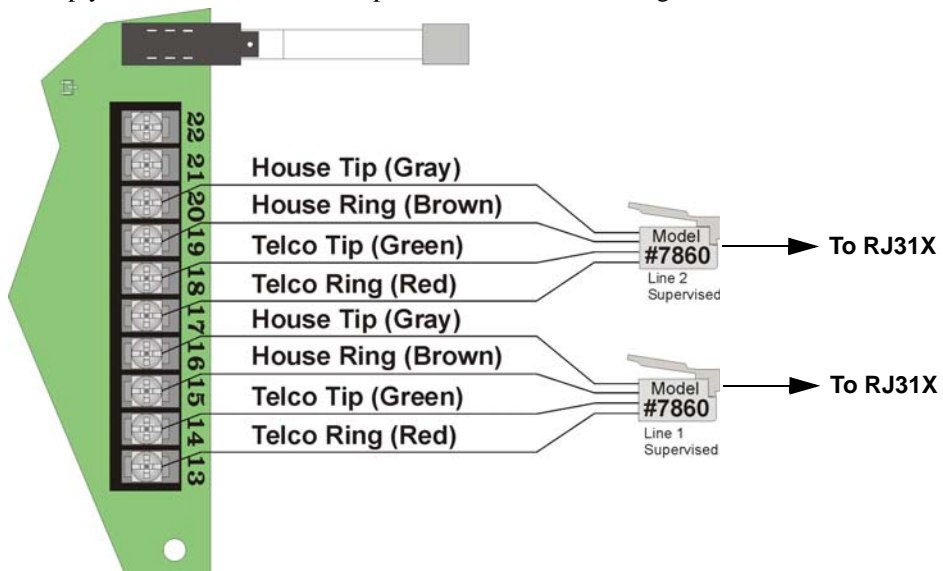

Figure 3-11 Telephone Line Connections

3.13 Model 5230 Installation

The optional 5230 remote annunciator provides both trouble and alarm annunciation, and a convenient means of English-language programming the system.

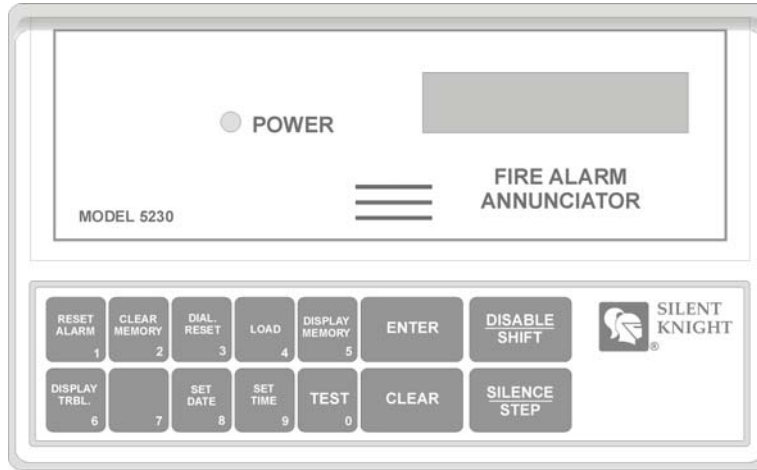

Figure 3-12 Model 5230 Remote Annunciator.

3.13.1 Mounting the 5230

When installing the 5230 as a permanent component of the system it must be mounted to a dual gang electrical box. All wire runs must use 12 to 18 AWG wire with a maximum length of 1000 feet. The annunciator must be supervised.

Follow these instructions to properly install the 5230 remote annunciator:

1. Remove the rear mounting plate:
By inserting a #4 flat blade screwdriver into the slot located on the bottom edge of the annunciator and gently turn the screwdriver until the mounting plate pulls away from the frame.
2. Secure the rear mounting plate to the dual gang electrical box.
Be sure to orientate the rear mounting plate so that the word "TOP" is toward the top of the plate and facing

toward you. See Figure 3-13.

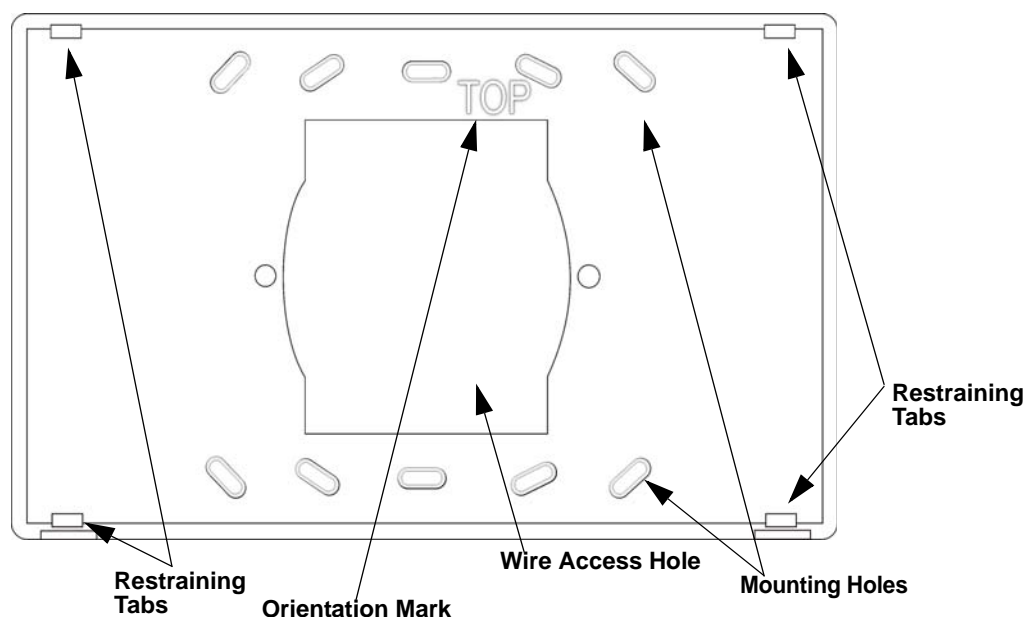

Figure 3-13 Rear Mounting Plate

- Set the desired ID for the 5230 by setting the dip switches (on = up) as follows:

ID Number	Dip Switch 1	Dip Switch 2	Dip Switch 3	Dip Switch 4
0*	On	On	On	On
1	Off	On	On	On
2	On	Off	On	On
3	Off	Off	On	On

* *Not supervised*

- Pull wire through the wire access hole and connect the wires as follows:

130294 Quick Connect Cable	5230 Terminals		5104 Terminals	
	Number	Description	Number	Description
Brown	1	Annunciator Ground	23	Ground
Red	2	Annunciator Power	24	Accessory Power
Orange	3	Annunciator Input	25	Serial Data Out
Yellow	4	Annunciator Output	26	Serial Data In

- Snap the 5230 into place by lining up the 5230 onto the restraining tabs and snapping the 5230 into place.
Note: Refer to Section 5 for 5230 Operation.

Section 4

Add-on Fire Communicator Application

The 5104 can be used to communicate the status of a larger or pre-existing (referred to as Host panel in this manual) fire control system that does not have a digital communicator. To configure the 5104 as an add-on communicator wire it as shown in Figure 4-1.

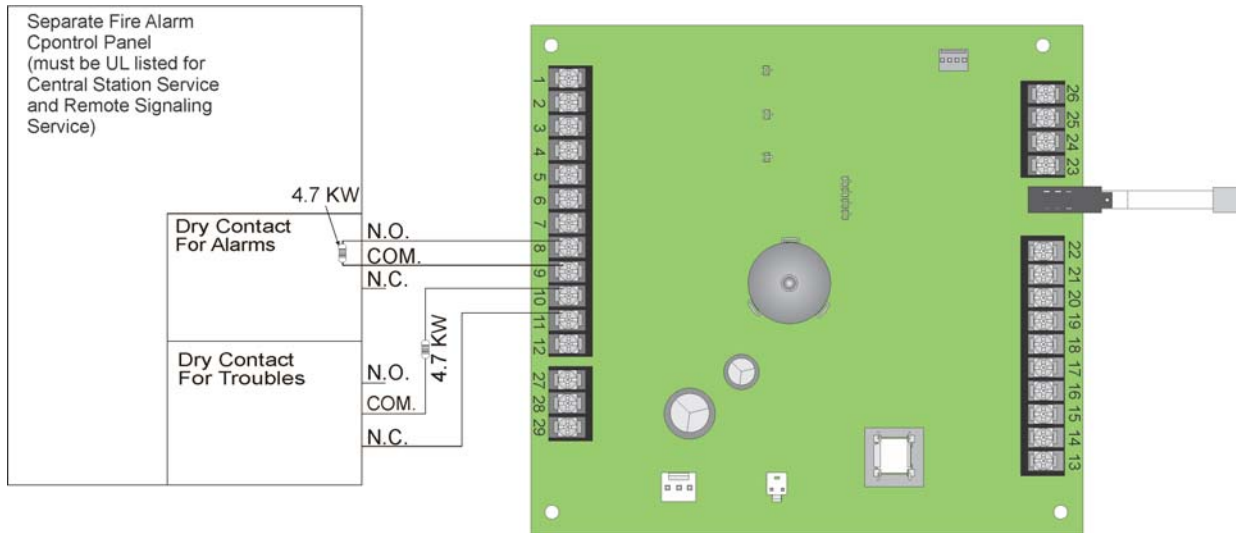

Figure 4-1 5104 Add-on Communicator Configuration Using 5104 Transformer for Power

Note: If power is supplied by the 5104 transformer, the host control panel must not send the 5104 a loss of AC signal.

If power is supplied by the 5104 transformer, do not select the Add-on Dialer option in programming.

Configure the zone inputs, phone lines and annunciator as shown in Section 3 of this manual.

Section 5

5230 Operation

This section contains information about the operation of the 5104 through a 5230 remote annunciator.

5.1 5230 Display Messages

If the 5104 is not reporting, being programmed, and if no functions are being entered, the LCD will display the event of the highest priority. For example if a supervisory and an alarm condition has occurred, the alarm condition will be displayed on the top line of the annunciator and any other low priority events will be displayed on the lower line of the annunciator in abbreviated form. (See Figure 5-1.)

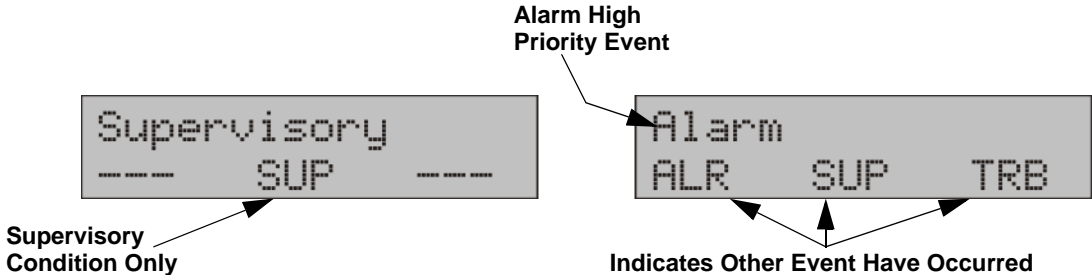

Figure 5-1 Example of Displayed Messages

Table 5-1 lists of the 5230 messages:

Table 5-1: 5230 LCD Messages and Meanings

Message	Meaning
Trouble Zone # (1-6)	Trouble condition exist on the zone or zones indicated by #
Alarm Zone # (1-6)	Alarm condition exist on the zone or zones indicated by #
Low AC	AC power has been lost.
Trouble Line 1	Trouble condition on phone line 1.
Trouble Line 2	Trouble condition on phone line 2.
Dialer Trouble	Indicates a dialer failed condition.
Earth Ground Fault	Indicates that an earth ground fault condition exists.
Earth Pwr Fault	Indicates that an earth ground to power, fault condition exists.
Silenced	A trouble condition exists and the annunciation has been turned off.
System Normal	Displayed if no trouble, alarm or 5230 system error exists.
Data Lost	Displayed if event memory overflows.
Reporting	A report is being transmitted to central station.
Up/Download	Data is being uploaded or downloaded from the central station computer.
Bus Trouble	The 5230 cannot communicate with 5104.
Try Again	If there is a 10 seconds time lapse between key presses while entering a function, the 5230 will display this message. An invalid entry was made.

Table 5-1: 5230 LCD Messages and Meanings

Message	Meaning
Trouble Remote # (1-3)	One or more 5230 annunciators are in trouble. The 5230 ID number is indicated in the # place.
EEPROM Sum Error	Error during program mode.
Low Battery	Battery voltage is less than 10.2 VDC.
Trouble Smk Pwr	Smoke loop power is less than 10 V or an overcurrent condition exists.
Bell Trouble	Trouble condition on the notification circuit.
Trouble Com 1	Auto test or manual test unable to report on line 1.
Trouble Com 2	Auto test or manual test unable to report on line 2.
Supervisory # (1-6)	Alarm condition on the zone programmed as the sprinkler zone.

5.2 5230 Touchpad Functions

There are several key functions used on the 5230 to input to the 5104, which are described in Table 5-2. However, as the 5230 is used with other control panels, not all the key function apply to the 5104.

Table 5-2: Touchpad Keystrokes and Their Task or Function



















Task or Function	Keystroke
Enter function or data. Used initiate any command or to enter a step parameter into programming memory.	 . See examples below.
Enter Program Mode.	  Installer Code.
Set Time.	  Installer Or Operator Code.
Manual Test. Sends a phone test to central station.	  Installer or Operator Code followed by the time in military (24 hr clock).
Clear. Used to delete the most recent key sequence from annunciator memory. Used to correct an incorrect entry.	
Shift. Used with other keys to enter alpha-numeric values. This key is labeled Disable/Shift, but is only used as a shift task.	
Silence. Used to silence audible trouble or alarm annunciations. Note: Trouble or supervisory annunciations will be silenced immediately when you press the silence key followed by the installer or operator code. Silences notification output, while 5230 remains audible.	 Installer or Operator Code.

Table 5-2: Touchpad Keystrokes and Their Task or Function

Task or Function	Keystroke
<p>Step. Used to advance to a different programming step while in programming mode. In reference to any programming tasks this key will be referred to as the "Step" key.</p>	 followed by the desired step number. Refer to Section 6 for programming information.
<p>Perform upload or download to a remote computer.</p>	  Installer Code.
<p>Display Troubles. Used to display any system troubles.</p>	  Installer or Operator Code.
<p>Display Memory Used to display all system events including Alarms, Troubles, and Supervisory conditions.</p>	  Installer or Operator Code.
<p>Dialer Reset. Resets dialer and discontinues communication attempts.</p>	  Installer Code.

Section 6 Programming

This section contains information pertaining to the programming of the 5104 with the 5230 Remote Annunciator. All programming is stored in an EEPROM (Electrically Erasable Read-Only Memory) chip, which is non-volatile memory storage. The various areas of programming are referred to as programming steps. These steps are covered in greater detail in Section 6.2.5.

6.1 UL 864 Programming Requirements

NOTICE TO USERS, INSTALLERS, AUTHORITIES HAVING JURISDICTION, AND OTHER INVOLVED PARTIES:			
This product incorporates field programmable software. In order for the product to comply with the requirements in the Standard for Control Units and Accessories for Fire Alarm Systems, UL 864, certain programming features or options must be limited to specific values or not used at all as indicated below.			
Programming Option	Permitted in UL 864 (Y/N)	Possible Settings	Settings Permitted in UL 864
Low AC Hours	Y	0 – 30 hours	1 – 3 hours
Test Interval	Y	4, 6, 12, 24 hours	4, 6, 12, 24 hours
Format #1 & Format #2	Y	3-4, 6-7	0,2,5,8
Add-on Dialer	N	Y & N	

6.2 5230 Programming

6.2.1 Default User Codes

The 5230 uses two programmable user codes (Installer and Operator codes). This section will refer to these user codes as either the Installer Code or the Operator Code. Table 6-1 lists the factory default Installer and Operator codes:

Table 6-1: Factory Default User Codes

User Codes	Factory Default
Installer Code	5104
Operator Code	1111

6.2.2 How to Enter and Exit Program Mode

This section describes how to enter and exit programming mode.

6.2.3 How to Enter Program Mode

Follow these steps to enter program mode:

1. Press 7.
2. Press ENTER.
3. Enter the Installer Code.

6.2.4 How to Exit Program Mode

To exit program mode press    

6.2.5 Step Programming

All programming, for the 5104, done through the 5230 is done in steps. Each step programs a set parameter of the 5104, such as phone numbers, reporting formats, and zone functions.

6.2.6 Maneuvering in Program Mode

This section describes how to maneuver through programming more efficiently.

6.2.6.1 Entering Selected Values

When in program mode the two-line display shows the step name on the first line and the shows the present value programmed for that step (see Figure 6-1).



Figure 6-1 Example of 5230 Display

To enter a new value into line 2, simple enter that value and press the enter key.

Yes or No Selections

When the selection choices are Yes or No, you can press any numbered key to toggle the selection between Yes or No then press the enter key to program your choice into memory.

Selecting Alpha-numeric characters

To enter a number 0-9, simply press the key corresponding to the digit(s) you desire. For example, to enter a phone number of 123-4567 press the keys, in order, 1234567 then enter.









To enter Alpha character (A-E) press the  followed by digits 1 (for A), 2 (for B), 3 (for C), 4 (for D), 5 (for E). For example, to enter a 3/1 Alarm Code of D (see Table 6-3 for step information), press

   to enter the D character.

Special Character and Functions

Some phone number require special characters or functions to dial the central station correctly. Table 6-2 lists the special character used for dialing a phone number and CIC (Carrier ID Code) codes.

Table 6-2: Special Characters for Dialing Sequence

Character	Touchpad Inputs	Displayed Character
Pause	 	A
*	 	B
#	 	C
Look for second dial tone.	 	D

6.2.6.2 Bypass a Step

To bypass a step to get to the next step, simply press the enter key without entering any data.

6.2.6.3 Go to a Step

You may desire to program only a few features and do not wish to step through the entire programming menu. To do this follow the steps below.

1. Press .
2. Enter the step number you wish to go to.
3. Press ENTER.

6.2.7 Programming Steps

Table 6-3 lists all the steps names, their task, the choices available in those steps, and the factory default setting of those steps.

Table 6-3: List of Programming Steps

Step #	Task	Choices	Default	
Step 0	3/1 Alarm Code	0 - 9, A, B, C, D, E	1	Sets the 3/1 reporting format code sent for an "Fire Alarm". Use the Shift key plus digits 1 - 5 for letters A - E.
Step 1	3/1 Sprnk Code	0 - 9, A, B, C, D, E	2	Sets the 3/1 reporting format code sent for a "Sprinkler Supervisory". Use the Shift key plus digits 1 - 5 for letters A - E.
Step 2	3/1 Trouble Code	0 - 9, A, B, C, D, E	8	Sets the 3/1 reporting format code sent for a "Trouble". Use the Shift key plus digits 1 - 5 for letters A - E.
Step 3	3/1 Restore Code	0 - 9, A, B, C, D, E	7	Sets the 3/1 reporting format code sent for a "Restore". Use the Shift key plus digits 1 - 5 for letters A - E.

Table 6-3: List of Programming Steps

Step #	Task	Choices	Default	
Step 4	3/1 Test Code	0 - 9, A, B, C, D, E	9	Sets the 3/1 reporting format code sent for a "Test Code". Use the Shift key plus digits 1 - 5 for letters A - E.
Step 5	Low AC Hours	0 - 30 hrs*	3	Set the number of hours the control panel will wait to report a loss of AC power to the central station.
Step 6	# Rings	0 - 15	0	Used to set the number of rings before the 5104 will answer the phone line to perform a download from a computer. 0 = disabled, which means the 5104 will not answer an incoming call.
Step 7	Line 1 DTMF	Yes or No	No	Yes = DTMF (Touch Tone) dialing enabled. No = Rotary dialing enabled. Press any number key to toggle the setting between "Yes" or "No".
Step 8	Line 1 Prefix	1 to 8 digits	None	Enter 8 digits to phone line 1. Use special characters to add pauses, #, *, and "look for second dial tone" characters into the line 1 prefix number. See Table 6-2 for special characters.
Step 9	Line 2 DTMF	Yes or No	No	Yes = DTMF (Touch Tone) dialing enabled. No = Rotary dialing enabled. Press any number key to toggle the setting between "Yes" or "No".
Step 10	Line 2 Prefix	1 to 8 digits	None	Enter 8 digits to phone line 2. Use special characters to add pauses, #, *, and "look for second dial tone" characters into the line 2 prefix number. See Table 6-2 for special characters.
Step 11	Must Report #1	Yes or No	No	Set phone number dialing priority. When the 5104 sends a report, it attempts to send the report to the priority phone number (see steps 16 - 19). If the priority phone number is not available, the system tries the other phone number. It continues to alternate between the two phone numbers until the report is sent to one of the phone numbers. If phone #2 is the phone number available, the report will go to #2. However, if the Must Report #1 option has been selected, the system will continue to try and send the report to phone #1. Press any numeric-digit to toggle the selection from Yes to No.
Step 12	Must Report #2	Yes or No	No	See also step 11. If phone #1 is the first phone number available, the report will go to phone #1. However, if the Must Report #2 option is selected, the system will continue trying to report to phone #2 until it succeeds or exhausts the programmed number of attempts.

Table 6-3: List of Programming Steps

Step #	Task	Choices	Default	
Step 13	Relay Alarm	Yes or No	No	Press any numeric-digit to toggle the selection from Yes to No. Yes = Bell circuit activates during alarm condition by the auxiliary relay. No = Bell circuit activates during a dialer failed condition.
Step 14	Relay Supervise	Yes or No	No	Press any numeric-digit to toggle the selection from Yes to No. Yes = Bell circuit is supervised (see Figure 3-10). No = Bell circuit in unsupervised (see Figure 3-9).
Step 15	# of 5230	0 - 3	0	Sets the number of annunciators that will be supervised. 0 = no supervision on any of the system annunciators.
Step 16	Send Alarm #1	Yes or No	Yes	Set priority for alarm reports. Press any numeric-digit to toggle the selection from Yes to No. Yes = Priority phone number is #1. No = Priority phone number is #2.
Step 17	Send Trouble #1	Yes or No	Yes	Set priority for trouble reports. Yes = Priority phone number is #1. No = Priority phone number is #2.
Step 18	Send Test #1	Yes or No	Yes	Set priority for manual and auto test reports. Yes = Priority phone number is #1. No = Priority phone number is #2.
Step 19	Report Sprnk #1	Yes or No	Yes	Set how zone 1 will report. Press any numeric-digit to toggle the selection from Yes to No. Yes = If you want to report troubles and alarms as a sprinkler (Supervisory), when using SIA format. No = If you want troubles and alarms to report as fires (Alarm). Note: Bells will only sound if "No" is selected.
Step 20	Report Sprnk #2	Yes or No	No	Set how zone 2 will report. Press any numeric-digit to toggle the selection from Yes to No. Yes = If you want to report troubles and alarms as a sprinkler (Supervisory), when using SIA format. No = If you want troubles and alarms to report as fires (Alarm). Note: Bells will only sound if "No" is selected.

Table 6-3: List of Programming Steps

Step #	Task	Choices	Default	
Step 21	Report Sprnk #3	Yes or No	No	<p>Set how zone 3 will report. Press any numeric-digit to toggle the selection from Yes to No.</p> <p>Yes = If you want to report troubles and alarms as a sprinkler (Supervisory), when using SIA format.</p> <p>No = If you want troubles and alarms to report as fires (Alarm).</p> <p>Note: Bells will only sound if “No” is selected.</p>
Step 22	Report Sprnk #4	Yes or No	No	<p>Set how zone 4 will report. Press any numeric-digit to toggle the selection from Yes to No.</p> <p>Yes = If you want to report troubles and alarms as a sprinkler (Supervisory), when using SIA format.</p> <p>No = If you want troubles and alarms to report as fires (Alarm).</p> <p>Note: Bells will only sound if “No” is selected.</p>
Step 23	Report Sprnk #5	Yes or No	No	<p>Set how zone 5 will report. Press any numeric-digit to toggle the selection from Yes to No.</p> <p>Yes = If you want to report troubles and alarms as a sprinkler (Supervisory), when using SIA format.</p> <p>No = If you want troubles and alarms to report as fires (Alarm).</p> <p>Note: Bells will only sound if “No” is selected.</p>
Step 24	Report Sprnk #6	Yes or No	No	<p>Set how zone 6 will report. Press any numeric-digit to toggle the selection from Yes to No.</p> <p>Yes = If you want to report troubles and alarms as a sprinkler (Supervisory), when using SIA format.</p> <p>No = If you want troubles and alarms to report as fires (Alarm).</p> <p>Note: Bells will only sound if “No” is selected.</p>
Step 25	Latch Sprnk	Yes or No	No	<p>Set how the sprinkler zone will operate. Press any numeric-digit to toggle the selection from Yes to No.</p> <p>Yes = When the sprinkler zone shorts for a duration longer than the Zone Response (set in steps 39 through 44), the annunciator remains active until reported or manually silenced.</p> <p>No = When the sprinkler zone shorts for a duration longer than the Zone Response (set in steps 39 through 44), the zone will follow system status and indicate a supervisory on that zone for the duration of the faulted condition.</p>

Table 6-3: List of Programming Steps

Step #	Task	Choices	Default	
Step 26	Account #1	6-digits	105104	Enter six-digits for an account number. For accounts shorter than 6-digits use leading zeros before you enter account number, so that all six places are filled. For example, if the format requires a shorter account number, such as 3/1 enter 000123.
Step 27	Attempts #1	3 - 5	3	Select the number of attempts the dialer will make to report to this account before a dialer failed condition occurs. the dialer will then call the other account. A total of 15 attempts will be made.
Step 28	Format #1	0 = SIA8 1 = Reserved 2 = SK4/2 3 = BFSK14 * 4 = BFSK23* 5 = SIA20 6 = 3/1 14* 7 = 3/1 23* 8 = Contact ID	SIA8	Selects the reporting format to be used on phone number 1. Enter the number of the choice (see choice column) to select the desired reporting format. See Section 7 for detailed information on the 5104 reporting formats. * for these choices, See Table 6-1
Step 29	CIC #1	1 to 8 digits	None	Carrier Identification Code is the prefix that needs to be dialed before a phone number to access a particular long distance carrier. Use special characters to add pauses, #, *, and "look for second dial tone" characters into the phone number. See Table 6-2 for special characters.
Step 30	Phone #1	1 to 16 digits	None	Enter 16 digits for phone number 1. Use special characters to add pauses, #, *, and "look for second dial tone" characters into the phone number. See Table 6-2 for special characters.
Step 31	Account #2	6-digits	205104	Enter up to six-digits for an account number. For accounts shorter than 6-digits use leading zeros before you enter account number, so that all six places are filled. For example, if the format requires a shorter account number, such as 3/1 enter 000123.
Step 32	Attempts #2	3 - 5	3	Select the number of attempts the dialer will make to report to this account before a dialer failed condition occurs. the dialer will then call the other account. A total of 15 attempts will be made.
Step 33	Format #2		SK4/2	See Step 28.
Step 34	CIC #2		None	See Step 29.
Step 35	Phone #2		None	See Step 30.
Step 36	Computer Account	6-digits	305104	Account number used when reporting to the downloading computer. If account number is shorter than 6-digits use leading zeros.

Table 6-3: List of Programming Steps

Step #	Task	Choices	Default	
Step 37	Computer CIC	1 to 8-digits	None	Carrier Identification Code is the prefix that needs to be dialed before a phone number to access a particular long distance carrier. Use special characters to add pauses, #, *, and "look for second dial tone" characters into the phone number. See Table 6-2 for special characters.
Step 38	Computer Phone	1 to 16-digits	None	Enter up to 16 digits for phone number 1. Use special characters to add pauses, #, *, and "look for second dial tone" characters into the phone number. See Table 6-2 for special characters.
Step 39	Zone Response #1	0 = 0.3 to 0.4 sec. 1 = 3 to 4 sec. 2 = 16 to 20 sec. 3 = 32 to 40 sec.	1	Select the speed that this zone will respond to alarm, trouble, or restore conditions. Selection 0 is not recommended, as it may cause unnecessary alarm. Selection 2 & 3 are considered delayed response. Delayed responses may be used only on waterflow switches, unless the waterflow switch has a built-in delay. Any selection other than 0 - 3 will scroll through the available selections.
Step 40	Zone Response #2		1	See Step 39
Step 41	Zone Response #3		1	
Step 42	Zone Response #4		1	
Step 43	Zone Response #5		1	
Step 44	Zone Response #6		1	
Step 45	Installers Code	4-digits	5104	Enter a 4-digit code to be used by the installer or service technician. The installer code allows the user to initiate downloads, set time, and entering program mode.
Step 46	Operators Code	4-digits	1111	Enter a 4-digit code to be used by the operator. The operator code allows the user to silence annunciations and to conduct manual tests.
Step 47	Test Time	24-hrs military time	01:30	Enter the time that a automatic test will be sent to central station. Use a 24-hour military time format. For example, to enter the time 5:15 pm enter 17:15. Use leading zeros for single-digit hours, such as 01:30 etc. Note: Any events that have not been re-stored will be sent along with the test report.
Step 48	Test Interval	0-3	3	Enter how often the control panel will do an automatic phone test, keyed off the Test Time. Selections 0-3 respectively; every 4 hours, 6 hours, 12 hours or 24 hours.*
* Panels with firmware V1.05 or before, enter how often (in days 1-30) the control panel will do an automatic phone test.				

Table 6-3: List of Programming Steps

Step #	Task	Choices	Default	
Step 49	Add-on Dialer	Yes or No	No	Press any numeric-digit to toggle the selection from Yes to No. Yes = If the 5104 is used as an add-on communicator for a host panel. This tells the 5104 not to test the battery or earth ground, which could cause interference with the host panel. No = The 5104 will test battery and earth ground. see Table 6-1

* For UL certified systems Low AC Hours in Step 5 must be set from 1 - 3 hours.

Section 7

Reporting

The 5104 can transmit information in 5 different formats. This section describes the five basic reporting formats of the 5104 and the codes that they send to a central station receiver. Of these 5 formats some of the formats offer a more specific selection for that format. For example, you can select a 3/1 format that requires a 1400 or 2300 Hz handshake, or SIA format that can handle 8 of 20 events per call. Selecting the correct format depends on the type of receiver that will receive calls from the 5104.

7.1 Reporting Formats

This section gives a description of each of the 5104 reporting formats. Refer to Table 7-1.

Table 7-1: Reporting Formats Descriptions

Format Name		Description
Category Name	Programming Name	
3/1	3/1 14	Old format, transmits a 3-digit account number and a 1-digit alarm code. Transmissions are acknowledged at 1400 Hz. See Table 6-1
	3/1 23	Old format, transmits a 3-digit account number and a 1-digit alarm code. Transmissions are acknowledged at 2300 Hz. See Table 6-1
4/2	SK 4/2	Tone burst format, transmits a 4-digit account code and 2-digit alarm code. Transmissions are acknowledged at 1400 Hz.
BFSK	BFSK14	Radionics format which transmits a high-speed, single-round, 3-digit account number, followed by report information. Transmissions are acknowledged at 1400 Hz. See Table 6-1
	BFSK23	Radionics format which transmits a high-speed, single-round, 3-digit account number, followed by report information. Transmissions are acknowledged at 2300 Hz See Table 6-1.
SIA	SIA8	Security Industry Association standard communication format which send a maximum of 8 events per call.
	SIA20	Security Industry Association standard communication format which send a maximum of 20 events per call. Up to a 6-digit account number.
Contact ID	Contact ID	Ademco Contact ID format. DTMF (Dual Tone Multiple Frequency) format. Send a 4-digit account number. Transmission are acknowledged at both 1400 and 2300 Hz.

7.2 Reporting Codes

Table 7-2 list the events sent by the 5104 and the code that is sent for that event by the type of reporting format used.

Table 7-2: Event and Reporting Code by Format

Event	SIA8 & 20	SK4/2	3/1 1400 &2300	BFSK14 & 23	Contact ID
Fire Alarm 1-6	FA1 - FA6	01 - 06	Alarm Code	01 - 06	1 110 001 - 1 110 006
Fire Alarm Restore 1-6	FH1 - FH6	21 - 26	Restore Code	E1 - E6	3 110 001 - 3 110 006
Fire Trouble 1-6	FT1 - FT6	61 - 66	Trouble Code	F1 - F6	1 373 001 - 1 373 006
Fire Trouble Restore 1-6	FJ1 - FJ6	71 - 76	Restore Code	E1 - E6	3 373 001 - 3 373 006
Sprinkler Supervisory 1-6	SS1 - SS6	01 - 06	Sprinkler Code	01 - 06	1 203 001 - 1 203 006
Sprinkler Supervisory Restore 1-6	SR1 - SR6	21 - 26	Restore Code	E1 - E6	3 203 001 - 3 203 006
Sprinkler Trouble 1-6	ST1 - ST6	61 - 66	Trouble Code	F1 - F6	1 203 001 - 1 203 006
Sprinkler Trouble Restore 1-6	SJ1 - SJ6	71 - 76	Restore Code	E1 - E6	3 203 001 - 3 203 006
Annunciator Trouble 1-3	ET1 - ET3	33	Trouble Code	FD	1 330 001 - 1 330 003
Annunciator Restore 1-3	ER1 - ER3	37	Restore Code	ED	3 330 001 - 3 330 003
Bell Trouble	ET32	33	Trouble Code	FD	1 320 001
Bell Restore	ER32	37	Restore Code	ED	3 320 001
Earth Ground Trouble	ET38	33	Trouble Code	FD	1 310 000
Earth Ground Restore	ER38	37	Restore Code	ED	3 310 000
Earth Power Trouble	ET39	33	Trouble Code	FD	1 310 000
Earth Power Restore	ER39	37	Restore Code	ED	3 310 000
Smoke (Loop) Power Trouble	ET40	33	Trouble Code	FD	1 300 000
Smoke (Loop) Power Restore	ER40	37	Restore Code	ED	3 300 000
Aux Power Trouble	ET43	33	Trouble Code	FD	1 300 003
Aux Power Restore	ER43	37	Restore Code	ED	3 300 003
AC Trouble	AT0	60	Trouble Code	FA	1 301 000
AC Restore	AR0	70	Restore Code	EA	3 301 000
Battery Trouble	YT0	69	Trouble Code	F9	1 302 000
Battery Restore	YR0	79	Restore Code	E9	3 302 000

Table 7-2: Event and Reporting Code by Format

Event	SIA8 & 20	SK4/2	3/1 1400 &2300	BFSK14 & 23	Contact ID
Trouble Phone Line #1	LT1	31	Trouble Code	FB	1 351 000
Restore Phone Line #1	LR1	35	Restore Code	EB	3 351 000
Trouble Phone Line #2	LT2	32	Trouble Code	FC	1 352 000
Restore Phone Line #2	LR2	36	Restore Code	EC	3 352 000
Communications Failure Line #1	YC1	31	Trouble Code	FB	1 351 000
Communications Restore Line #1	YK1	35	Restore Code	EB	3 351 000
Communications Failure Line #2	YC2	32	Trouble Code	FC	1 352 000
Communications Restore Line #2	YK2	36	Restore Code	EC	3 352 000
Manual Test	RX0	30	Test Code	EE	1 601 000
Automatic Test (Normal)	RP0	30	Test Code	EE	1 602 000
Automatic Test (Abnormal)	RY0	Test 9	Test Code	EE	1 608 000
Downloading Passed	RS0	30	Test Code	EF	1 412 000
Downloading Failed	RU0	30	Test Code	FF	1 413 000
Data Lost	RT0	39	Trouble Code	FE	1 354 000

Section 8

Troubleshooting

This section contains trouble shooting information for servicing the 5104. The following is a list of LED indications, 5230 LCD messages, and their meaning. Along with this information are possible causes of these problems and some solution.

LED Indications	5230 LCD Messages	Meaning	Cause and Correction
	Trouble Zone # (1-6)	Trouble condition exist on the zone or zones indicated by #	The device connected to this zone is in trouble. EOL problem on this loop. This indication will clear once the problem has been corrected
	Alarm Zone # (1-6)	Alarm condition exist on the zone or zones indicated by #	The device connected to this zone is in the alarm condition.
L3 Off	Low AC	AC power has been lost.	Check for power on the primary of the transformer.
L6 On	Trouble Line 1	Trouble condition on line 1.	Phone line or phone connections are bad or unable to report to central station. Verify the programmed central station phone number.
L7 On	Trouble Line 2	Trouble condition on line 2.	
L5 On	Dialer Trouble	Indicates a dialer failed condition.	
	Earth Ground Fault	Indicates that an earth ground fault condition exists.	
	Earth Pwr Fault	Indicates that an earth power fault condition exists.	
L4 On.	Silenced	A trouble condition exists and the annunciator has been turned off.	EOL problem on this loop. This indication will clear once the problem has been corrected
	Data Lost	Displayed if event memory overflows.	
	Bus Trouble	The 5230 cannot communicate with 5104.	
	Try Again	If there is a 10 seconds time lapse between key presses while entering a function, the 5230 will display this message.	You waited to long between touchpad entries and the system timed out or an incorrect entry was made.
	Trouble Remote #	One or more 5230 annunciator is in trouble. The 5230 ID number is indicated in the # place.	Check for shorts or opens in wire runs. Check to make sure that none of the 5230 have the same ID code.
	EEPROM Sum Error	Error during program mode.	Exit program mode (see Section 6.2.4) then re-enter program mode and try again.
L2 On	Trouble Smk Pwr	Smoke loop power is less than 10 V or an overcurrent condition exists. Overcurrent draw on terminal 6, 9, or 11.	

LED Indications	5230 LCD Messages	Meaning	Cause and Correction
	Bell Trouble	Trouble condition on the notification circuit.	Over current draw on the notification circuit. Missing or incorrect EOL on a supervised notification circuit.
L6 Flashes	Trouble Com 1	Event reports, auto test or manual test unable to report on line 1.	Phone line voltage is O.K. but the panel was unable to communicate on line 1. Try dialing the phone number that you programmed, from a premise phone, to verify it is reaching the central station. If that checks out O.K. verify that you are using a compatible reporting format with that receiver.
L7 Flashes	Trouble Com 2	Event reports, auto test or manual test unable to report on line 2.	Phone line voltage is O.K. but the panel was unable to communicate on line 2. Try dialing the phone number that you programmed, from a premise phone, to verify it is reaching the central station. If that checks out O.K. verify that you are using a compatible reporting format with that receiver.
	Supervisory # (1-6)	Alarm condition on the zone programmed as the sprinkler zone.	Short on the programmed sprinkler zone.
	Low Battery	Backup battery voltage is below 10.2 VDC.	Check backup battery connection. Check backup battery voltage level with volt meter. Replace the backup battery.
L1 On	Blank	+12 Accessory power fault	Check for over current on terminal 24.

Fire Product Warranty and Return Policy

General Terms and Conditions

- All new fire products manufactured by Honeywell have a limited warranty period of 36 months from the date of manufacture against defects in materials and workmanship. See limited warranty statement for details.
- This limited warranty does not apply to those products that are damaged due to misuse, abuse, negligence, exposure to adverse environmental conditions, or have been modified in any manner whatsoever.

Repair and RMA Procedure

- All products that are returned to Honeywell for credit or repair require a RMA (Return Authorization) number. Call Customer Service at 800-328-0103 or 203-484-7161 between 8:00 A.M. and 5:00 P.M. EST, Monday through Friday to obtain a return authorization number.
- Technical Support is available at 800-446-6444 between 8:00 A.M. and 5:00 P.M. CST, Monday through Friday.
- All returns for credit are subject to inspection and testing at the factory before actual determination is made to allow credit.
- RMA number must be prominently displayed on the outside of the shipping box. See return address example under Advanced Replacement Policy.
- Included with each return should be: a packing slip that has the RMA number, a content list, and a detailed description of the problem.
- All products returned to Honeywell must be sent freight pre-paid. After product is processed, Honeywell will pay for shipping product back to customer via UPS ground.
- Return the Silent Knight product circuit board only. Products that are returned in cabinets will be charged an additional \$50 to cover the extra shipping and handling costs over board only returns. **Do not return batteries.** Honeywell has the authority to determine if a product is repairable. Products that are deemed un-repairable will be returned to the customer.
- Product that is returned that has a board date code more than 36 months from date of manufacture will be repaired and the customer will be assessed the standard Honeywell repair charge for that model.

Advanced Replacement Policy

- Honeywell offers an option of advance replacement for fire product printed circuit boards that fail during the first 6 months of the warranty period. These items must be returned with transportation charges prepaid and must be accompanied by a return authorization.
- For advance replacement of a defective board, contact your local Honeywell distributor or call Honeywell at 800-328-0103 to obtain a RMA (Return Authorization) number and request advanced replacement.
- A new or refurbished board will be shipped to the customer. The customer will initially be billed for the replacement board but a credit will be issued after the repairable board is received at Honeywell. All returned products must comply with the guidelines described under “General Terms and Conditions” and “Repair and RMA Procedure”.
- The defective board must be returned within 30 days of shipment of replacement board for customer to receive credit. No credit will be issued if the returned board was damaged due to misuse or abuse.
- Repairs and returns should be sent to:
Honeywell Fire Systems
Attn: Repair Department / RA Number _____
12 Clintonville Road
Northford, CT 06472 USA

Manufacturer Warranties and Limitation of Liability

Manufacturer Warranties. Subject to the limitations set forth herein, Manufacturer warrants that the Products manufactured by it in its Northford, Connecticut facility and sold by it to its authorized Distributors shall be free, under normal use and service, from defects in material and workmanship for a period of thirty six months (36) months from the date of manufacture (effective Jan. 1, 2009). The Products manufactured and sold by Manufacturer are date stamped at the time of production. Manufacturer does not warrant Products that are not manufactured by it in its Northford, Connecticut facility but assigns to its Distributor, to extent possible, any warranty offered by the manufacturer of such product. This warranty shall be void if a Product is altered, service repaired by anyone other than Manufacturer or its authorized Distributors. This warranty shall also be void if there is a failure to maintain the Products and the systems in which they operate in proper working conditions.

MANUFACTURER MAKES NO FURTHER WARRANTIES, AND DISCLAIMS ANY AND ALL OTHER WARRANTIES, EITHER EXPRESSED OR IMPLIED, WITH RESPECT TO THE PRODUCTS, TRADEMARKS, PROGRAMS AND SERVICES RENDERED BY MANUFACTURER INCLUDING WITHOUT LIMITATION, INFRINGEMENT, TITLE, MERCHANTABILITY, OR FITNESS FOR ANY PARTICULAR PURPOSE. MANUFACTURER SHALL NOT BE LIABLE FOR ANY PERSONAL INJURY OR DEATH WHICH MAY ARISE IN THE COURSE OF, OR AS A RESULT OF, PERSONAL, COMMERCIAL OR INDUSTRIAL USES OF ITS PRODUCTS.

This document constitutes the only warranty made by Manufacturer with respect to its products and replaces all previous warranties and is the only warranty made by Manufacturer. No increase or alteration, written or verbal, of the obligation of this warranty is authorized. Manufacturer does not represent that its products will prevent any loss by fire or otherwise.

Warranty Claims. Manufacturer shall replace or repair, at Manufacturer's discretion, each part returned by its authorized Distributor and acknowledged by Manufacturer to be defective, provided that such part shall have been returned to Manufacturer with all charges prepaid and the authorized Distributor has completed Manufacturer's Return Material Authorization form. The replacement part shall come from Manufacturer's stock and may be new or refurbished. THE FOREGOING IS DISTRIBUTOR'S SOLE AND EXCLUSIVE REMEDY IN THE EVENT OF A WARRANTY CLAIM.

Warn-HL-08-2009.fm



**SILENT
KNIGHT**

by Honeywell

Silent Knight
12 Clintonville Road
Northford, CT 06472-1610
203-484-7161
Fax: 203-484-7118

www.silentknight.com